



## 3.5GHz and 5G Antenna Solutions

Your Antenna Partner. We advise, design and deliver.

*“Alpha Wireless’ new narrow beam antennas have enabled us to implement an efficient spectral reuse, while also improving network quality. We are still pushing the limits of what we can do with these antennas.”*

**Colin Browne, Head of RF Engineering, Imagine Communications**





## Your Antenna Partner

Building a network using 3.5GHz, CBRS or C-Band spectrum is a smart business decision. Demand for connectivity is surging, and it's one more step toward ending the digital divide. As promising as this spectrum is, however, new technologies can present unexpected obstacles.

Alpha Wireless has deep experience designing 3.5 GHz networks. We'll collaborate with you to fulfill your business plan at the lowest total cost of ownership. We're flexible. Use our available solutions, or we'll rapidly customize within your build schedule.

## Better Coverage for 4G and 5G

Improved performance and coverage reduce the number of antennas you need.

Improve network throughput by 30%

Increase sector capacity by 12%

## Antennas Designed to Optimize Your Network



### Reduce Interference

Upper side lobes on an antenna's elevation pattern can cause unwanted radiation, interfere with desired signals and erode service levels. Most antenna vendors only suppress the first upper side lobe. Every Alpha Wireless antenna suppresses all upper side lobes by >18 dBi. In addition, our narrow-beam 33-degree antennas suppress the azimuth side lobes by >25 dB, greatly reducing interference. Customer results show 2.7 dBi to nearly 6 dBi gain in carrier to noise interference ratio (CINR), a marked improvement in throughput and network performance.

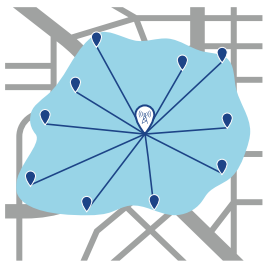

### Improve Coverage

Alpha Wireless external antennas require 25 percent fewer sites to deliver the same coverage as radio-integrated antenna solutions. You save on network infrastructure capital investments, operational and maintenance costs.

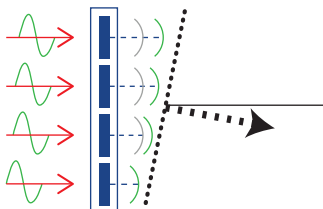

### Optimize With Tilt Options

Alpha Wireless variable tilt antennas optimize tuning in your network. Each antenna has a different tilt setting based on the location and your network topography. You get more efficient coding schemes and can offer better user data rates.

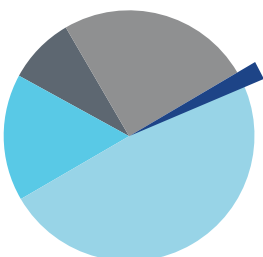

### Cost Effective

While antennas make up a small part of a site's cost, choosing a high-quality antenna from Alpha Wireless greatly reduces overall capital investment by reducing nodes. With our expertise and our flexible, collaborative approach, you install antennas for the long term, avoiding early rip-and-replace.

# CBRS Panels

## AW3014-T0-F

Frequency	3300-3800 MHz
Port	2
Beamwidth	65°
Gain	18 dBi
Tilt	T0° (FET)

Dimensions: 750mm (29.5") x 160mm (6.2") x 81mm (3.1") - (L x W x H)

[Click here for full AW3014-T0-F specs](#)

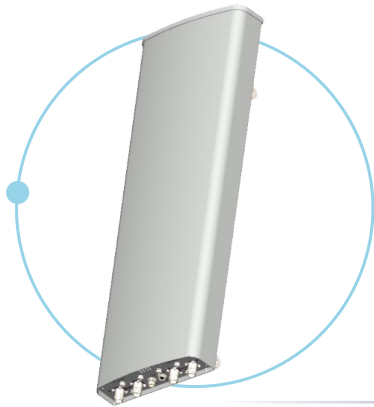
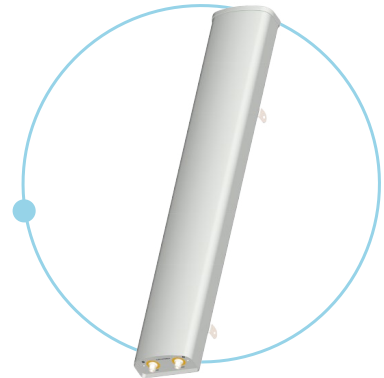

## AW3023-T0-F

Frequency	3300-3800 MHz
Port	4
Beamwidth	65°
Gain	18 dBi
Tilt	T0° (FET)

Dimensions: 750mm (29.5") x 280mm (11") x 85mm (3.3") - (L x W x H)

[Click here for full AW3023-T0-F specs](#)

## AW3161-E-F-V2

Frequency	3300-3800 MHz
Port	4
Beamwidth	65°
Gain	17.9 dBi
Tilt	T0°-T10° (RET)

Dimensions: 850mm (33.5") x 280mm (11") x 85mm (3.3") - (Lx W xD)

[Click here for full AW3161-E-F-V2 specs](#)

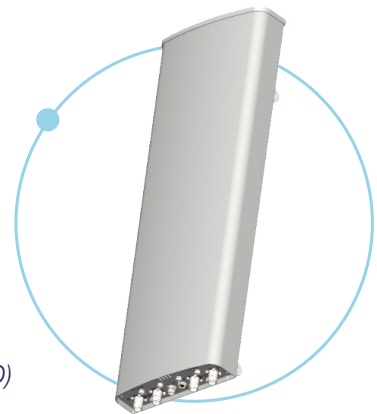

## AW3161-M-F-V2

Frequency	3300-3800 MHz
Port	4
Beamwidth	65°
Gain	17.9 dBi
Tilt	T0°-T10° (MET)

Dimensions: 850mm (33.5") x 280mm (11") x 85mm (3.3") - (LxW xD)

[Click here for full AW3161-M-F-V2 specs](#)

**FET:** Fixed Electrical Tilt - AW3XXX-T0-F (Zero degrees fixed tilt)

**MET:** Manual Electrical Tilt - AW3XXX-M-F

**RET:** Remote Electrical Tilt - AW3XXX-E-F

X = Product Code

## AW3376-E-F

<b>Frequency</b>	3400-3800 MHz
Port	8+1
<b>Beamwidth</b>	90°
Gain	15.5 dBi
<b>Tilt</b>	T0°-T10° (RET)

Dimensions: 1040mm (41") x 320mm (12.6") x 105mm (4.1") - (LxWxH)

[Click here for full AW3376-E-F specs](#)

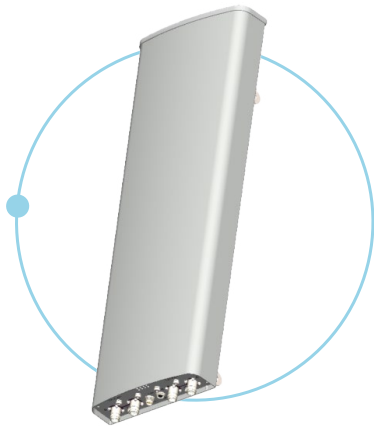
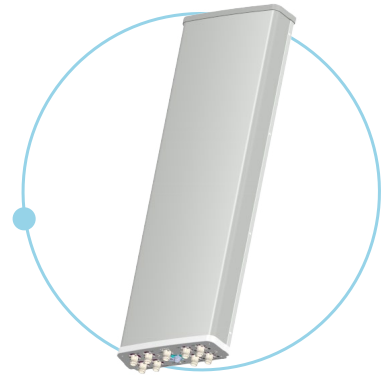

## AW3523-E-F

<b>Frequency</b>	3300-3800 MHz
Port	4
<b>Beamwidth</b>	45°
Gain	18.5 dBi
<b>Tilt</b>	T0°-T10° (RET)

Dimensions: 1002mm (39.4") x 412mm (16.2") x 107mm (4.2") - (LxWxD)

[Click here for full AW3523-E-F specs](#)

## AW3711-E-F

<b>Frequency</b>	3400-3800 MHz
Port	4
<b>Beamwidth</b>	33°
Gain	20.1 dBi
<b>Tilt</b>	T0°-T10° (RET)

Dimensions: 840mm (32.7") x 322mm (12.7") x 107mm (4.2") - (LxWxD)

[Click here for full AW3711-E-F specs](#)

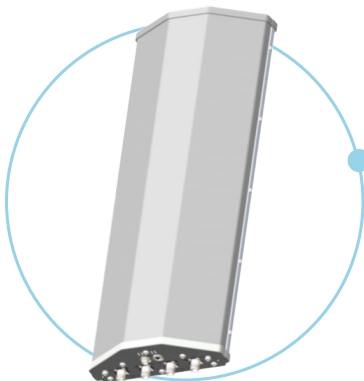
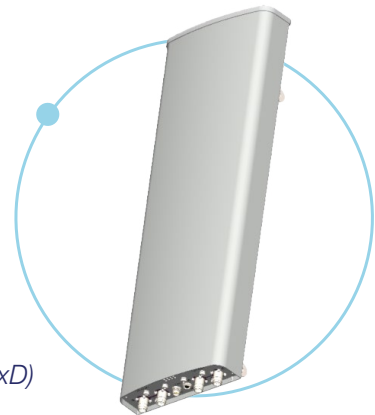

## AW3795-E-F

<b>Frequency</b>	3400-3800 MHz
Port	4
<b>Beamwidth</b>	33°
Gain	20.1 dBi
<b>Tilt</b>	T0°-T10° (RET)

Dimensions: 855mm (33.7") x 322mm (12.7") x 115mm (4.5") - (LxWxD)

[Click here for full AW3795-E-F specs](#)

**FET:** Fixed Electrical Tilt - AW3XXX-T0-F (Zero degrees fixed tilt)

**MET:** Manual Electrical Tilt - AW3XXX-M-F

**RET:** Remote Electrical Tilt - AW3XXX-E-F

X = Product Code



# CBRS Small Cell

## AW3372-T0-F

Frequency	3300-3800 MHz
Port	2
Beamwidth	65°
Gain	12.5 dBi
Tilt	T0° (FET)

Dimensions: 303mm (11.9") x 140mm (5.5") x 35mm (1.3") - (L x W x H)

[Click here for full AW3372-T0-F specs](#)

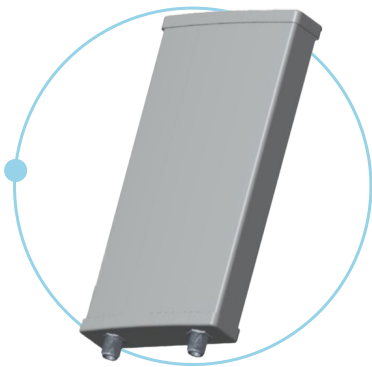
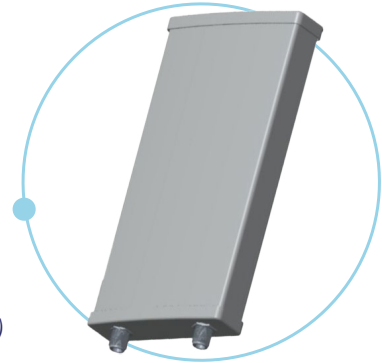

## AW3373-T0-F

Frequency	3300-3800 MHz
Port	2
Beamwidth	90°
Gain	11 dBi
Tilt	T0° (FET)

Dimensions: 303mm (11.9") x 140mm (5.5") x 35mm (1.3") - (L x W x H)

[Click here for full AW3373-T0-F specs](#)

## AW3374-T0-F

Frequency	3400-3800 MHz
Port	2
Beamwidth	360°
Gain	7 dBi
Tilt	T0° (FET)

Dimensions: 312mm (12.3") x 80mm (3.1") - (L x Ø)

[Click here for full AW3374-T0-F specs](#)

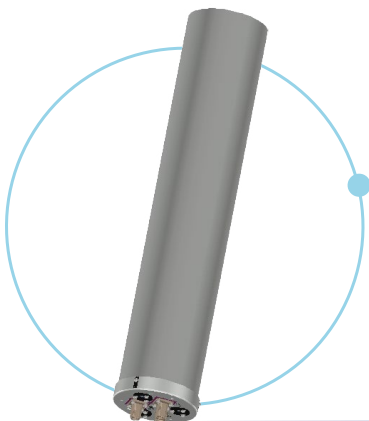
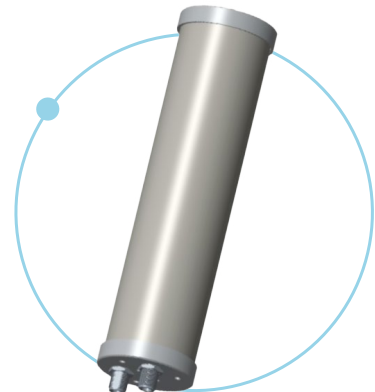

## AW3625-M-F-G

Frequency	3300-3800 MHz
Port	2
Beamwidth	360°
Gain	8.5 dBi
Tilt	T0°-T10° (MET)

Dimensions: 700mm (27.5") x 125mm (4.9") - (L x Ø)

[Click here for full AW3625-M-F-G specs](#)

FET: Fixed Electrical Tilt - AW3XXX-T0-F (Zero degrees fixed tilt)

MET: Manual Electrical Tilt - AW3XXX-M-F

RET: Remote Electrical Tilt - AW3XXX-E-F

X = Product Code

## AW3672-M-F-G

<b>Frequency</b>	3400-3800 MHz
Port	4
<b>Beamwidth</b>	360°
Gain	8.5 dBi
<b>Tilt</b>	T0°-T10° (MET)

Dimensions: 600mm (23.6") x 220mm (8.6") - (L x Ø)  
[Click here for full AW3672-M-F-G specs](#)

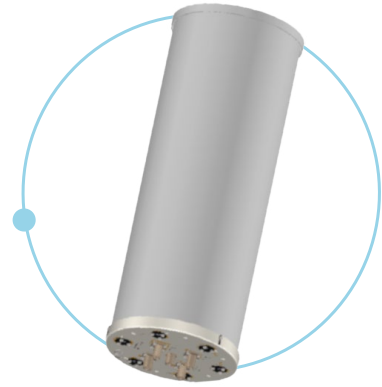

## C-Band

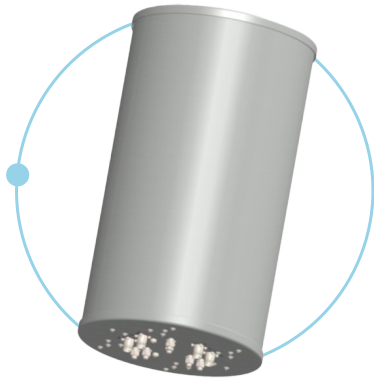

## AW3825-T0-F

<b>Frequency</b>	3300-4200 MHz
Port	4
<b>Beamwidth</b>	360°
Gain	12.5 dBi
<b>Tilt</b>	T0° (FET)

Dimensions: 660mm (26") x 370.8mm (14.6") - (L x Ø)  
[Click here for full AW3825-T0-F specs](#)

## AW3828-E-F

<b>Frequency</b>	3300-4200 MHz
Port	4
<b>Beamwidth</b>	65°
Gain	17.3 dBi
<b>Tilt</b>	T0°-T10° (RET)

Dimensions: 850mm (33.5") x 280mm (11") x 85mm (3.3") - (LxWxD)  
[Click here for full AW3828-E-F specs](#)

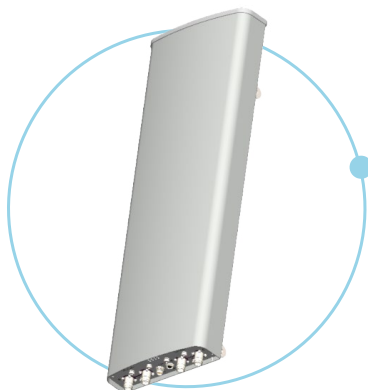

## AW3829-E-F

<b>Frequency</b>	3700-4200 MHz
Port	4
<b>Beamwidth</b>	33°
Gain	19.7 dBi
<b>Tilt</b>	T0°-T10° (RET)

Dimensions: 840mm (32.7") x 322mm (12.7") x 107mm (4.2") (LxWxD)  
[Click here for full AW3829-E-F specs](#)



**CONTACT US**

**Europe**

Ashgrove Business Centre, Ballybrittas, Portlaoise,  
Co. Laois, R32 DTOA, Ireland.  
E: sales@alphawireless.com  
T: +353 57 8633847

**US**

7301 W. 129th Street, Suite 150 Overland Park,  
KS 66213, USA  
E: sales@alphawireless.com  
T:+1 913 279 0008

**Australia  
Maser**

Unit 9, 15B Rodborough, PO Box 6298,  
Frenchs Forest, DC NSW 2086 Australia.  
E: info@maser.com.au  
P:+61 29452 6062

Find out more at [www.alphawireless.com](http://www.alphawireless.com)